

Produkt-Datenblatt

Technische Daten, Spezifikationen

Kontakt

**Technischer und kaufmännischer Vertrieb, Preis-
auskünfte, Angebote, Test-Geräte, Beratung vor Ort:**

Tel: (0 81 41) 52 71-0

FAX: (0 81 41) 52 71-129

Aus dem Ausland:

Tel: ++49 - 81 41 - 52 71-0

FAX: ++49 - 81 41 - 52 71-129

E-Mail: sales@meilhaus.com

Internet:

www.meilhaus.com

Web-Shop:

www.MEsstechnik24.de | www.MEasurement24.com

Web Kontakt-Formular:

www.meilhaus.de/infos/Kontakt.htm

Per Post:

Meilhaus Electronic GmbH

Am Sonnenlicht 2

D-82239 Alling bei München

MEsstechnik fängt mit ME an.

www.meilhaus.com

Erwähnte Firmen- und Produktnamen sind zum Teil
eingetragene Warenzeichen der jeweiligen Hersteller.
Preise in Euro zzgl. gesetzl. MwSt. Irrtum und Änderung
vorbehalten.

© Meilhaus Electronic bzw. Hersteller:
www.meilhaus.de/infos/impressum.htm

MEILHAUS
ELECTRONIC



Intelligent Alarms

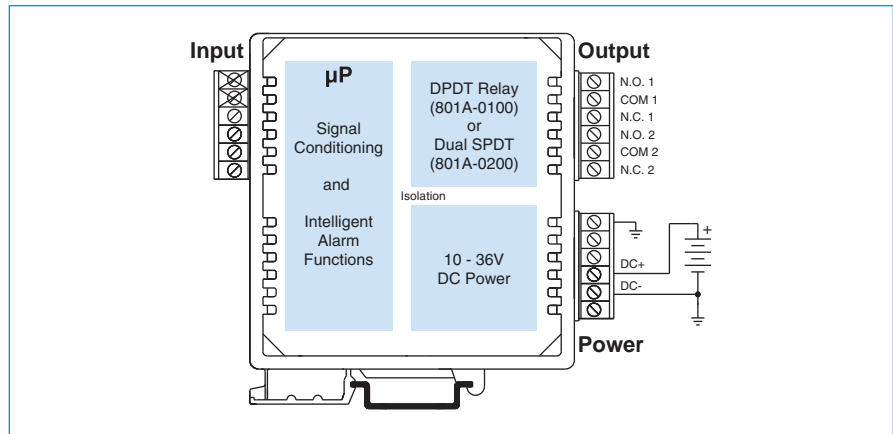

801A Alarms

Thermocouple, RTD, and Millivolt Input

Models

- 801A-0100: Alarm with one DPDT relay
- 801A-0200: Alarm with two SPDT relays

Input Ranges

- TC types: J, K, T, R, S, E, B, N
- Millivolt: $\pm 15.625\text{mV}$ to $\pm 1.0\text{V DC}$
- RTD: 100 ohm Pt, 120 ohm Ni, 10 ohm Cu
- Resistance: 0 to 500 ohms

Alarm Outputs

- Single DPDT electro-mechanical 5A relay (-0100),
- Dual SPDT electro-mechanical 5A relays (-0200)

Power Requirement

10 to 36V DC

Approvals

UL, cUL listed.

Description

IntelliPack alarms compare inputs against user-defined limit setpoints to control built-in relays.

Each unit offers a selection of input ranges and alarm functions to handle a broad range of applications. As your needs change, you can easily reconfigure the unit for different ranges or functions. Alarm functions available on all models include on/off controller, limit alarm, window alarm, deviation alarm, rate-of-change alarm, and peak/valley detection.

Setup is very easy. IntelliPack alarms are configured through a user-friendly Windows XP/Vista/7 program. Field adjustments and recalibration are quickly performed with front-panel push-buttons and status LEDs. Once configured, IntelliPacks operate independent of any host computer.

Special Features

- Integrated microcontroller performs intelligent signal processing for advanced alarm functions.
- Windows XP/Vista/7 software configuration speeds setup and replacement.
- Push-button reprogrammability facilitates changes in the field without a host PC.
- Multi-purpose inputs accept numerous ranges to reduce spare stock requirements.
- High-resolution Sigma-Delta A/D converter delivers high accuracy with low noise.

- Input excitation supply on each input provides power for a two-wire transmitter.
- Dual alarm operation lets you perform two alarm functions at the same time.

Performance

General Input

Analog to Digital (A/D) Converter
16-bit $\Sigma\text{-}\Delta$ A/D converter.

Resolution

$\pm 0.005\%$ of span or $0.1^\circ\text{C}/\text{LSB}$. ADC typically yields resolutions finer than $0.1^\circ\text{C}/\text{LSB}$.

Ambient Temperature Effect

Better than $\pm 0.005\%$ of input span per $^\circ\text{C}$ or $\pm 1\mu\text{V}$, whichever is greater.

Noise Rejection

Normal Mode: Better than 40dB @ 60Hz .
Common Mode: Better than 130dB @ 60Hz .

Input Filter

Normal mode filtering, plus digital filtering optimized and fixed per input range within $\Sigma\text{-}\Delta$ ADC.

Input Response Time

Less than 200mS to 98% of final value for a step change in the input. A software programmable delay can be implemented for filtering transients.

Relay Time Delay

Adjustable alarm delay of up to 25 seconds.

Input Overvoltage Protection

Bipolar Transient Voltage Suppressors (TVS).

Continued on next page.

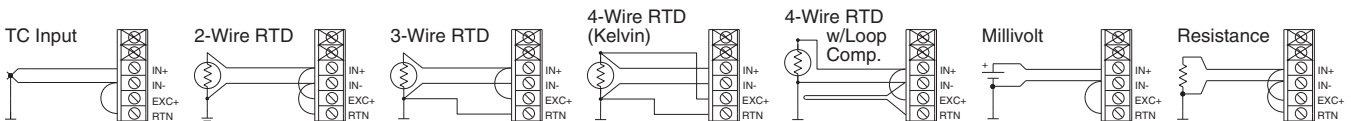



■ DC Millivolt Input

DC Millivolt/Voltage Input Ranges

±1.0V	±125mV	±31.25mV
±500mV	±62.5mV	±15.625mV
±250mV		

Millivolt Accuracy

Better than ±0.05% of input span.

■ Thermocouple Input

Thermocouple Input Ranges

Thermocouple type user configured. Signal linearization, cold-junction compensation, and open circuit or lead break detection are included.

TC	°C Range (°F Range)	Accuracy
J	-210 to 760°C (-346 to 1400°F)	±0.5°C
K	-200 to 1372°C (-328 to 2502°F)	±0.5°C
T	-260 to 400°C (-436 to 752°F)	±0.5°C
R	-50 to 1768°C (-58 to 3214°F)	±1.0°C
S	-50 to 1768°C (-58 to 3214°F)	±1.0°C
E	-200 to 1000°C (-328 to 1832°F)	±0.5°C
B	260 to 1820°C (500 to 3308°F)	±1.0°C
N	-230 to 1300°C (-382 to 2372°F)	±0.5°C

■ RTD Input

RTD Input Ranges

100Ω Pt, 120Ω Ni, or 10Ω Cu; user-configured.

RTD	°C Range (°F Range)	Accuracy
Pt ¹	-200 to 850°C (-328 to 1562°F)	±0.25°C
Pt ²	-200 to 850°C (-328 to 1562°F)	±0.25°C
Ni	-80 to 320°C (-112 to 608°F)	±0.25°C
Cu	-200 to 260°C (-328 to 500°F)	±1.00°C

Alpha: Pt¹ (α = 1.3850), Pt² (α = 1.3911), Ni (α = 1.6720), Cu (α = 1.4272).

2, 3, or 4-wire configurations supported. Module provides sensor excitation, linearization, lead-wire compensation, and sensor break detection.

RTD Excitation Current

1mA DC typical, all types.

RTD Lead-Wire Compensation

25 ohms per lead.

RTD Break Detection

Configurable for either upscale or downscale.

■ Resistance Input

Resistance Input Range

0 to 500 ohms.

Resistance Accuracy

±0.05 ohms.

■ Output

Relay (801A-0100 models)

One DPDT electro-mechanical relay.
Contact material Silver Nickel (AgNi 90/10).

Relays (801A-0200 models)

Two independent SPDT electro-mechanical relays.
Contact material Silver-Cadmium Oxide (AgCdO).

Relay Ratings (CSA ratings)

25V DC @ 5A. 120/240V AC @ 5A.

Expected Mechanical Life

20 million operations.

■ Environmental

Ambient Temperature

Operating: -25 to 70°C (-13 to 158°F).
Storage: -40 to 85°C (-40 to 185°F).

Relative Humidity

5 to 95%.

Power Requirements

10 to 36V DC. 55mA @ 24V. 75mA @ 15V.

Isolation

3-way (input/output/power).
1500V AC for 60 seconds or 250V AC continuous.

Radiated Field Immunity (RFI)

EN61000-4-3, EN50082-1.

Electromagnetic Field Immunity (EMI)

No relay trips will occur beyond ±0.25% of input span from setpoint under the influence of electromagnetic fields from switching solenoids, commutator motors, and drill motors.

Electrical Fast Transient (EFT)

EN61000-4-4, EN50082-1.

Surge Withstanding Capability (SWC)

EN61000-4-5, EN50082-1.

Electrostatic Discharge (ESD)

EN61000-4-2, EN50082-1.

Radiated Emissions

EN50081-1 for Class B equipment.

Approvals

UL, cUL listed (USA, Canada).
UL3121 - general product safety.

■ Configuration

Software Configuration

Units are fully programmable via the Windows XP/Vista/7 IntelliPack Configuration Program. Configuration downloads from PC through EIA232 serial port using Acromag 800C-SIP kit.

Field Configuration

Setpoint and deadband are configurable via push-buttons and a standard calibrator.

LED Indicators

LEDs indicate power, status, and alarm.

■ Physical

Enclosure

Case: Self-extinguishing NYLON type 6.6 polyamide thermoplastic UL94 V-2, color beige; general purpose NEMA Type 1 enclosure.

Connectors (Removable terminal blocks)

Wire Range: AWG #14-22 (AWG #12 stranded only).

Printed Circuit Boards

Military grade FR-4 epoxy glass circuit board.

Dimensions

1.05W x 4.68H x 4.35D inches.
26.7W x 118.9H x 110.5D millimeters.

Shipping Weight

1 pound (0.45 Kg) packed.

■ Ordering Information

IMPORTANT: All IntelliPacks require initial software configuration (order 800C-SIP). See Note 1 below.

801A-0100

IntelliPack alarm unit.
One TC/RTD/millivolt input, one DPDT relay.

801A-0200

Same as above except two SPDT relays.

800C-SIP

Software Interface Package.
Only one kit is required for all IntelliPack models.
See diagram on Page 83 for included parts.

5034-225

USB-to-RS232 adapter. See page 121 for more info.

P55R-D24

Power supply (24V DC, 2.1A).
See Power Supplies on Page 199.

TBK-B01

Optional terminal block kit, barrier strip style, 2 pcs.
(Does not include terminal block for input wiring.)

TBK-S01

Optional terminal block kit, spring clamp style, 2 pcs.
(Does not include terminal block for input wiring.)

NOTE 1: To order factory configuration, call Acromag for a configuration form which must accompany your order. Also, append "-C" to model number (example: 801A-0200-C). 800C-SIP kit is still recommended.

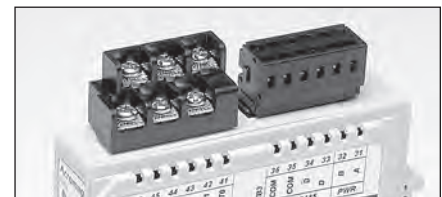

Optional terminal blocks: barrier strip (left) and spring clamp (right). Cage clamp terminal is standard.



Dimensions

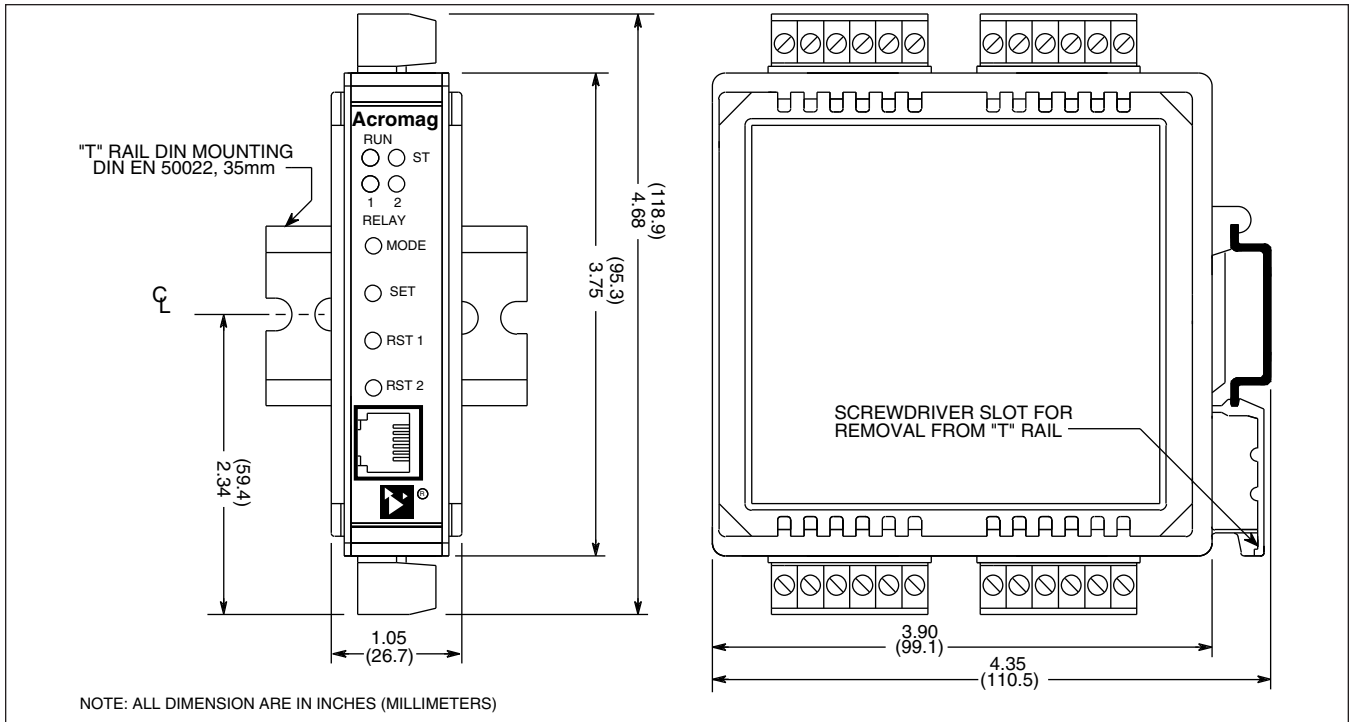



Accessories

Terminal Blocks



Barrier strip (left) and spring clamp (right).

Ordering Information

See individual I/O modules for compatibility.

Barrier Strip Terminal Blocks

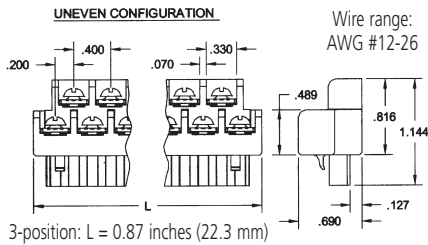
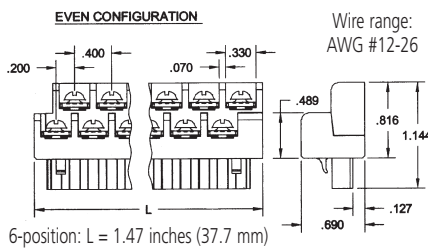

TBK-B01
Terminal block kit,
two 6-position pieces

TBK-B03
Terminal block kit,
one 3-position and
three 6-position pieces

TBK-B02
Terminal block kit,
four 6-position pieces

Spring Clamp Terminal Blocks

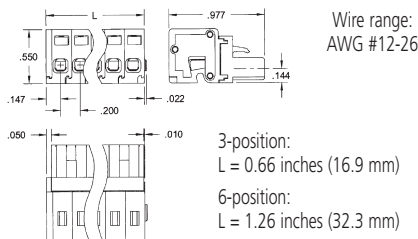

TBK-S01
Terminal block kit,
two 6-position pieces

TBK-S03
Terminal block kit,
one 3-position and
three 6-position pieces

TBK-S02
Terminal block kit,
four 6-position pieces

Mounting Hardware



DIN-Rail Mounting

For your convenience, Acromag offers several mounting accessories to simplify your system installation. Our 19" rack-mount kit provides a clean solution for mounting your I/O modules and a power supply. Or you can buy precut DIN rail strips for mounting on any flat surface.

Ordering Information

20RM-16-DIN
19" rack-mount kit with DIN rail.

DIN RAIL 3.0

DIN RAIL 16.7

DIN rail strip, Type T, 3 inches (75mm) or 16.7 inches (425mm)

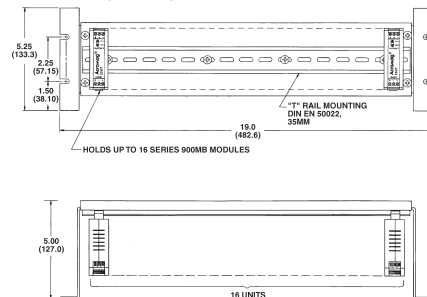

Power Supplies



50W Supply

Input Power Requirement
85 to 264V AC or 105 to 370V DC

Output
24V DC, 2.1A (50W)

Ordering Information

PS5R-D24
Universal 50W power supply

See Power Supplies on Page 199 for other models and more information.

USB / RS232 Adapter



Length: 3.15 in (8.0 cm)
Height: 0.80 in (2.03 cm)
Width: 1.75 in (4.44 cm)
Weight: 1.6 oz (45.36 g)

Ordering Information

5034-225
USB-to-RS232 adapter

AC Current Sensor

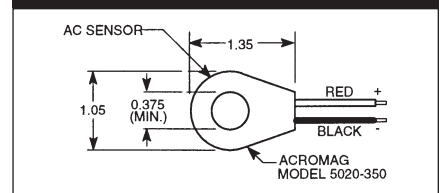

Ordering Information

5020-350
AC current sensor (See page 205)